



**880/890 Series
Frameless Bypass Enclosure**

Installation Instructions

Illustration of Parts Breakdown

Set Contents

NO.	QTY	Description
①	1pc	Header (S207)
②	2pc	Wall Jamb (S701)
③	6pc	Plastic Wall Anchor (2-477)
④	6pc	No. 8 x 1" Flat Head Screw (2-236)
⑤	2pc	Frameless Door Panel (DOOR)
⑥	2pc	Soft Jamb Bumper (SDSJG)
⑦	2pc	No. 6 x 1/2" Pan Head Screw (2-282)
⑧	1pc	Door Knob (FINGERPULL)
⑨	1pc	Towel Bar (TOWELBAR24)
⑩	1pc	Lower Guide (SDLJG)
⑪	1pc	Bottom Guide (SFGUIDE-CLR)
⑫	1pc	Bottom Sill with Clear Vinyl Strip. (S200) (SDTCLEAR)
⑬	4pc	Hanger Bracket (S-225)
⑭	12pc	Hanger Bracket Screws (2-482)
⑮	4pc	Rollers (SDROLLER)
⑯	4pc	Hanger Screws (2-291)

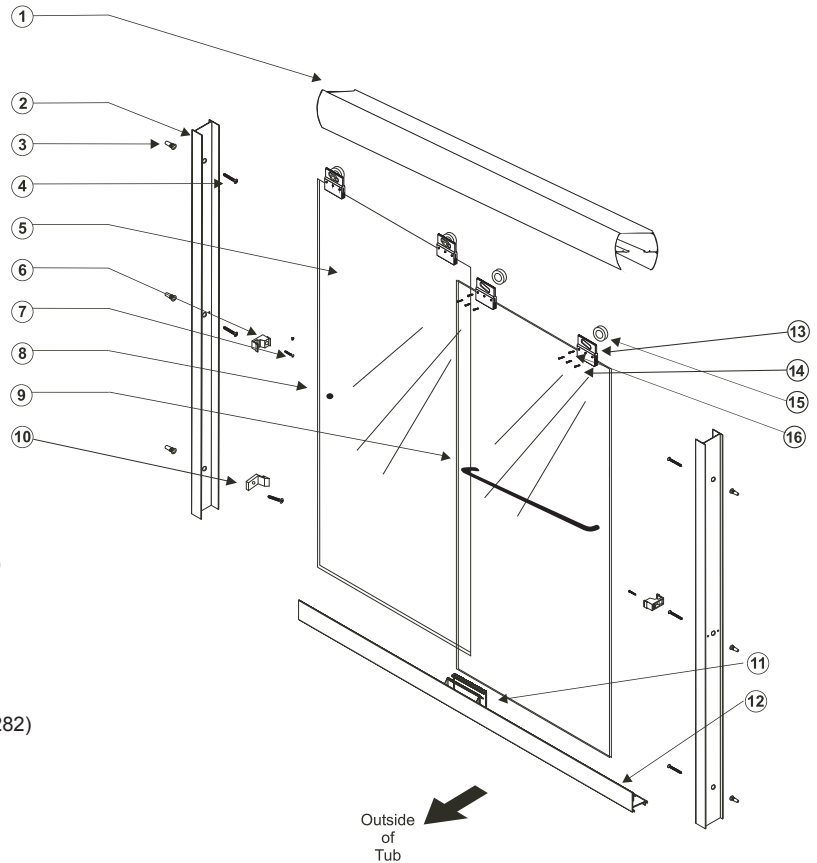

CAUTION:
Tempered Glass cannot be cut or drilled.

IMPORTANT: Before beginning installation, read instructions thoroughly and carefully. Always protect your eyes with safety goggles.

1. TOOLS REQUIRED FOR INSTALLATION

#2 Phillips Screwdriver

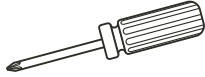

Level

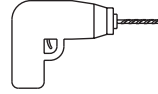
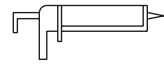
 Drill with
 1/8" Drill Bit &
 3/16" Masonry Drill Bit

 Caulking
 (clear silicone
 recommended)

Mallet



Pencil



Tape Measure



Hacksaw/Fine Tooth Blade

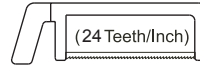

File

Step 1

Measure wall-to-wall. Cut bottom sill with vinyl strip (12) 3/8" shorter than determined dimension. Position bottom sill (12) in center of tub rim with lip of track to exterior. Mark bottom sill (12) location with pencil on both sides of bottom sill (12). Using level, position wall jamb (3) over bottom sill (12) at marks with longer legs toward opening. Mark through holes provided for anchoring drill 3/16" holes and insert anchors (4) for masonry applications. Use 1/8" tap holes for fiberglass and acrylic units, secure jambs (3) to wall with #8 x 1" screws (5).

NOTE: May need to file bottom of wall jambs (3) to follow contour of tub.

Step 2

Measure wall-to-wall opening above wall jambs (3). Cut header (1) 1/16" shorter than determined dimension. Place header (1) onto wall jambs (3).

Step 3

Install Towel Bar (9) and knob (10) in holes provided in glass.

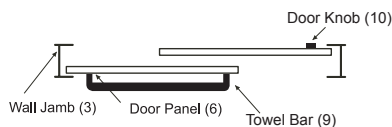
Step 4

Begin with carefully setting inside panel (6) in tub. Install exterior panel (6) first from inside of tub. Lift panel (6) into position with rollers engaging into roller slot of header (1). Repeat for interior panel (6).

For maximum water proofing, position interior door panel(6) closest to shower head.

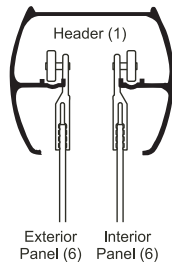

Once it is determined which wall jamb (3) the interior panel (6) will close into, remove bottom screw (5) from wall jamb (3) and insert lower guide (10) with flange on inside of tub or shower. Re-secure thru hole provided in guide (10) into wall jamb (3).

Note: If door panels (6) are not parallel to wall jambs (3), remove door panels (6) and adjust rollers to compensate.

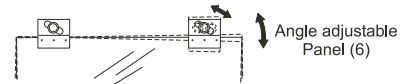
Step 5

Align the slots on jamb bumpers (7) with outer edges of door panel (6). Snap jamb bumpers (7) into wall jamb (3) at middle screw location. Install jamb bumper (7) with a No. 6 x 1/2" pan head screw (8). Repeat process for other side of unit.

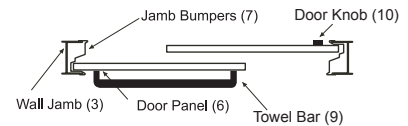
Step 6

Slide both door panels (6) to one side. Position bottom guide (11) in middle of bottom sill (12). Snap bottom guide (11) into grooves at location. Door panels (6) are ready to slide back and forth inside track.

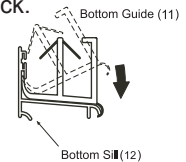
Step 7

Carefully caulk the interior and exterior of the enclosure assembly. Caulk along bottom sill (12) wall jambs (3) and inside wall jambs (3) at bottom sill (12)

Note: Allow the caulk to dry 24-hours before using enclosure. Use only silicone caulk.

