

COX

SERIES 15

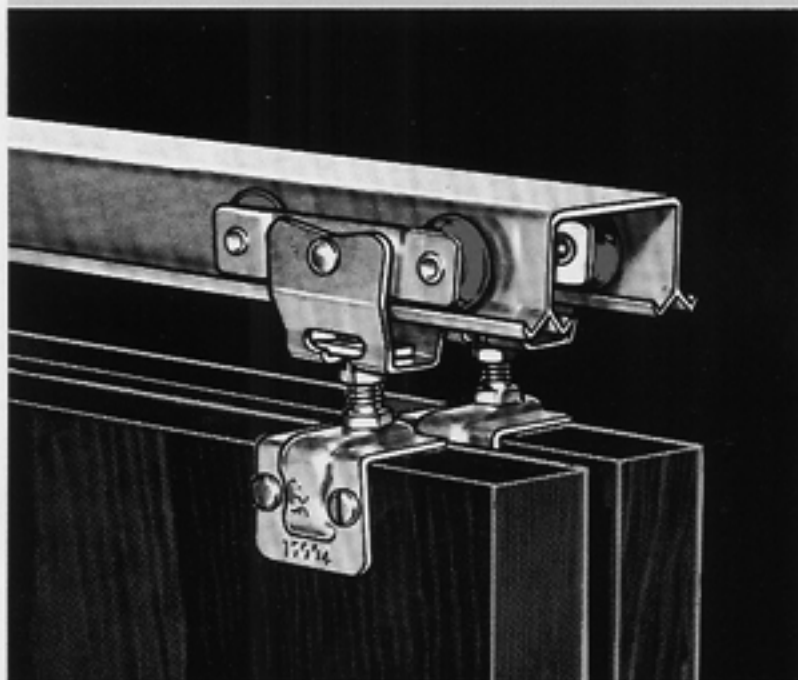

COMMERCIAL DOORS give extra years of smooth, quiet service with Cox heavy-duty door hardware.

Cox Series 15 Commercial Sliding Door Hardware is rugged and smooth-rolling for long, trouble-free service on doors in High Rise Hotels and Motels, Churches, Schools, Hospitals and other Institutions, Restaurants and Night Clubs, Office Buildings and Factories.

EASY OPERATION: Cox's exclusive spoke design maintains true concentricity for permanently smooth, quiet operation of Celcon® wheels. Two 4-wheel self-leveling hangers equalize the load for quiet, finger tip control. Smooth rolling axle bearings, factory lubricated for a lifetime of silent service... **EASY INSTALLATION AND ADJUSTMENT:** Install track and hangers, then hang doors. A single adjusting nut on each hanger bracket allows quick adjustment of height above floor. No drilling required for bracket adjustment screw.

Cox fully guaranteed Series 15 Commercial Hardware is standardized to reduce the required variety of parts - economy priced - and built to last!

Heavy duty commercial

SLIDING

door hardware

for 3/4" to 1 3/4"

(19mm to 44mm) doors

up to 100 lbs. (45.4kg) each



*single... by-passing...
bi-parting or multiple*

Cox.

COX DOOR HARDWARE MAKES GOOD DOORS BETTER

COX

SERIES 15

up to 100 lbs. (45.4 kg) each
heavy duty commercial

sliding door hardware

features smooth operation and durability



PRE-LUBRICATED
SMOOTH ROLLING
AXLE BEARING WHEELS



EXCLUSIVE SPOKE WHEEL
FOR TRUE WHEEL
CONCENTRICITY



SELF-LEVELING
8-WHEEL SUSPENSION



HEAVY DUTY SERVICE



HANG DOORS WITHOUT
REMOVING HANGERS
FROM TRACK



SIDE OR TOP MOUNT
BRACKETS



EASY ADJUSTMENT



DOUBLE OR SINGLE
EXTRUDED ALUMINUM TRACK

COX QUALITY is Economical... Every Cox part is manufactured from materials of unquestioned quality by skilled workmen steeped in a long tradition of quality control. This is your assurance of enduring satisfaction. Simplified design and up-to-the-minute methods permit large manufacturing economies, which we pass on to you in the form of highly competitive prices.

DESIGNED FOR FAST, EFFICIENT INSTALLATION... A glance at the detail sketches shows why COX SERIES 15 allows high speed, accurate installation of heavy sliding doors. Note how easy it is to put the bracket adjusting plate into the slot on the hanger. It takes only seconds, without removing the hanger from the track. Then, a quick turn of the adjusting nut and the door is installed!

PACKAGED HARDWARE SETS: Complete with all necessary parts except aluminum track. •

HARDWARE SELECTOR

Track

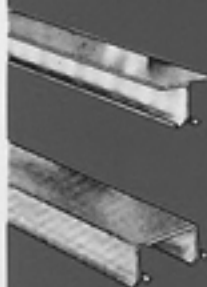

15-200
Single aluminum
track for single,
bi-parting and
multiple doors.

15-220
Double aluminum
track for 1 1/8",
1 3/8" and 1 3/4"
(29mm, 35mm,
and 44mm)
bypassing doors.

Hangers



15-001
Hanger with
side bearings.



15-002
Top mount bracket
for all doors.



15-003
Side mount
bracket for 3/4",
1 1/8" and 1 3/4"
(19mm, 29mm,
and 44mm) doors.



15-004
Side mount
bracket for 1 1/8",
1 3/8" and 1 3/4"
(29mm, 35mm,
and 44mm) doors.

Floor Guides



04-023
Nylon, for all
single doors.



04-003
Nylon fixed guide
for 1 3/8" (35mm)
bypassing doors.



04-020
Nylon, adjustable
For 3/4" to 1 3/8"
(19mm to 35mm)
bypassing doors.

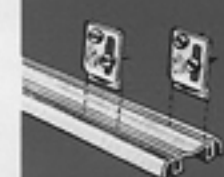

04-029
Adjustable, nylon
tipped. Use with
04-400 aluminum
threshold.



04-400
Aluminum
threshold for 3/4"
to 1 3/8" (19mm to
35mm) bypassing
doors.

For 3/4" (19mm) Doors



USE 15-200 TRACK

TOP MOUNT



USE 15-001 CARRIERS WITH
15-002 MOUNTING BRACKETS

SIDE MOUNT

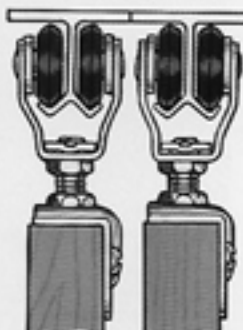

USE 15-003 USE 15-003

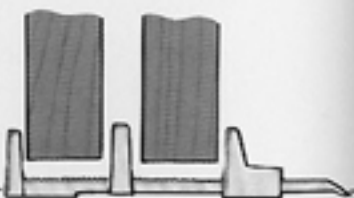

USE 15-001 CARRIERS WITH
15-003 MOUNTING BRACKETS AND
04-020 or 04-023 GUIDES

SEE PACKAGED HARDWARE SETS*

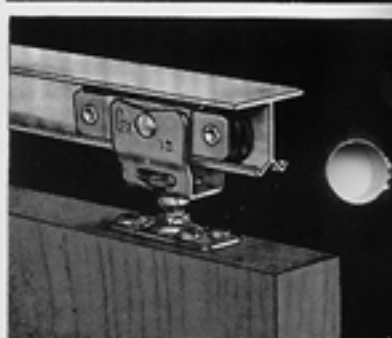

For 1 1/8" (29mm) Doors

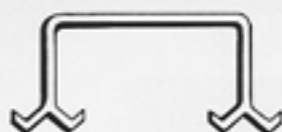

USE 15-220 TRACK

For 1 3/8" (35mm) Doors

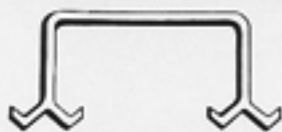

USE 15-220 TRACK

For 1 3/4" (44mm) Doors

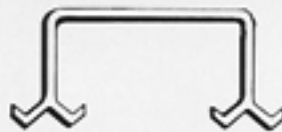

USE 15-220 TRACK

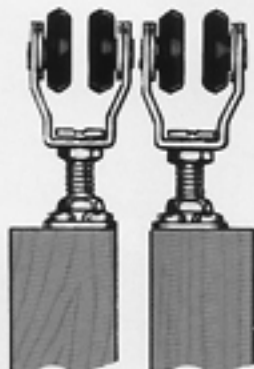

USE 15-001 CARRIERS WITH
15-002 MOUNTING BRACKETS

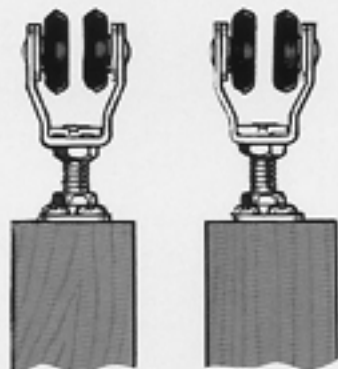

USE 15-001 CARRIERS WITH
15-002 MOUNTING BRACKETS

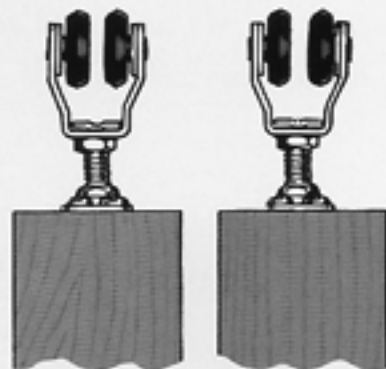

USE 15-001 CARRIERS WITH
15-002 MOUNTING BRACKETS

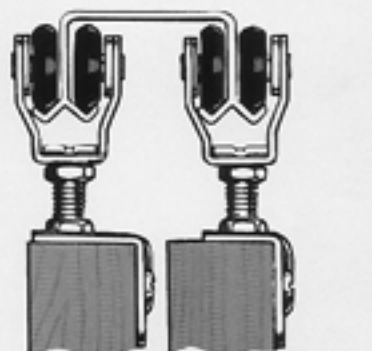

USE 15-004 USE
15-004 15-003

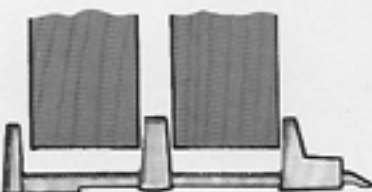

USE 15-001 CARRIERS WITH 15-004
and 15-003 BRACKETS AND 04-020 or
04-023 GUIDES

SEE PACKAGED HARDWARE SETS *

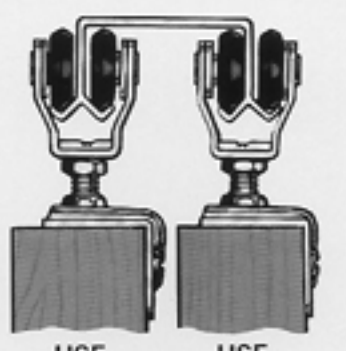

USE 15-004 USE
15-004 15-004

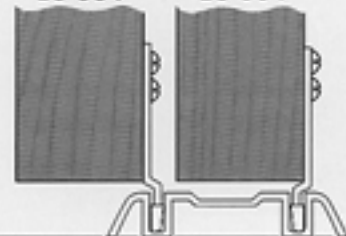

USE 15-001 CARRIERS WITH 15-004
MOUNTING BRACKETS. USE 04-003,
04-020, 04-023 or 04-009 GUIDES.

SEE PACKAGED HARDWARE SETS *

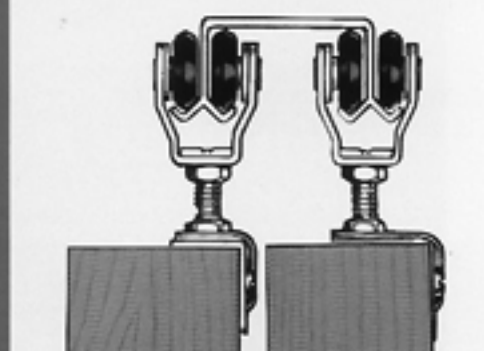

USE 15-003 USE
15-003 15-004

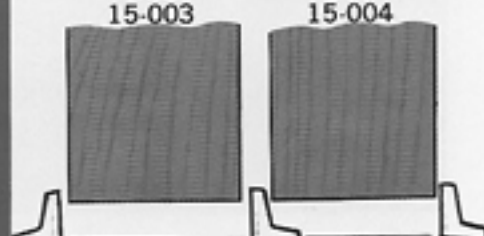

USE 15-001 CARRIERS WITH 15-003
and 15-004 MOUNTING BRACKETS
AND 04-023 GUIDES.

SEE PACKAGED HARDWARE SETS *

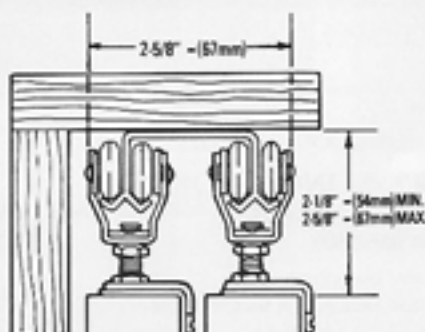
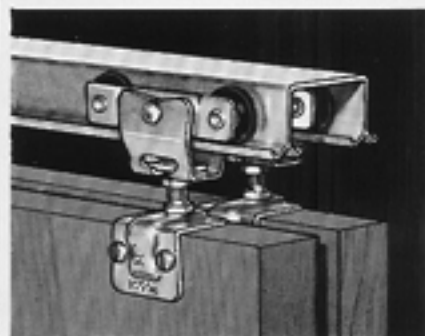

* PACKAGED HARDWARE SETS

Consists of: Carriers, Mounting Brackets, Guides,
Wrench, Screws and Instruction Sheet.
Select Hardware Set Number required for door.

FOR TOP MOUNT ON SINGLE DOOR	15-040
FOR SIDE MOUNT ON SINGLE DOOR	15-041
FOR TOP MOUNT ON DOUBLE DOOR	15-042
FOR SIDE MOUNT ON DOUBLE DOORS:	
3/4" (19mm) DOORS	15-043
1 1/8" (29mm) DOORS	15-044
1 3/8" (35mm) DOORS	15-045
1 3/4" (44mm) DOORS	15-044

Select Cox Quality for
smooth R-O-L-L-I-N-G
commercial doors

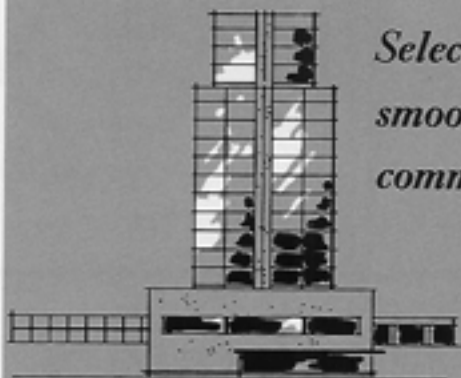

Quiet convenience for restaurants,
night clubs, apartments,
condominiums, high rise hotels.



Prevent disturbing sounds from
interrupting church, school, or
other institutional activities.



Expanded office space for privacy or conferences
at the touch of a finger.

INSTALLATION OPTIONS — SERIES 15

SINGLE DOOR



BY-PASSING DOORS

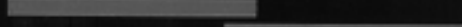

BI-PARTING DOORS



MULTIPLE DOORS

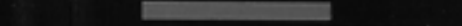

ARCHITECTURAL SPECIFICATIONS

Sliding doors shall be suspended from Cox (specify type) extruded aluminum track. Hangers shall be Cox axle bearing of plated steel with vertical adjustment provided by easy screw action and four spoke-design Celcon® wheels.

Doors shall be guided at bottom by Cox (specify type) Nylon adjustable guides. Threshold, if used, shall be Cox No. 04-400 of extruded aluminum.

Track, threshold and other hardware shall be manufactured by Arthur Cox & Sons, Inc., Industry, California.

COX SLIDING DOOR AND FOLDING DOOR HARDWARE IS AVAILABLE THROUGH LEADING DISTRIBUTORS & DEALERS.

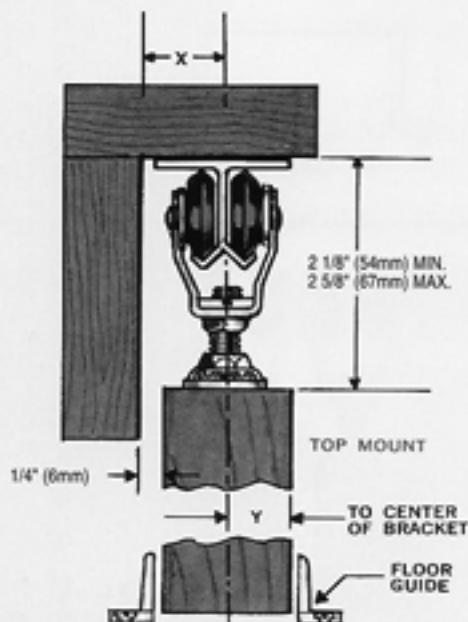

INSTALL TRACK AND BRACKETS

SPACING FOR	3/4\"/>
SIDE MOUNT BRACKET AT X:	11/16\"/>
TOP MOUNT BRACKETS AT X:	11/16\"/>
TOP MOUNT BRACKETS AT Y:	FRONT DOOR — 11/16\"/>

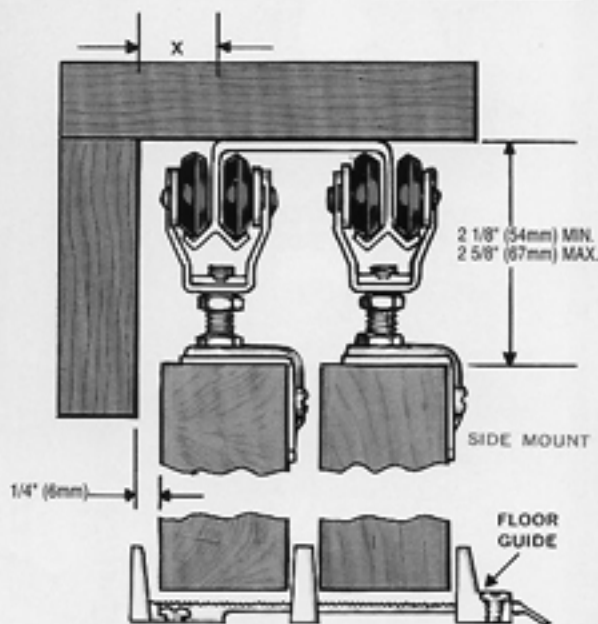

TYPICAL END VIEW DETAIL — Scale 1/2" = 1"
(12.5mm = 25mm)

COX HARDWARE MAKES GOOD DOORS BETTER!

ARTHUR COX & SONS, INCORPORATED

18311 East Railroad Street • Industry, CA 91748

(818) 965-1565 • FAX (818) 965-7507

Export: Overseas Operations, Incorporated

P.O. Box 7000-222 • Redondo Beach, CA 90277-5779

TEL: (310) 540-4600 • FAX (310) 540-8382

Your Local Distributor:



© 1995 Arthur Cox & Sons, Incorporated

Printed in U.S.A.
CX07-115 (REV 8/95)